

MODEL DSP – DATA STATION PLUS



FOR USE IN HAZARDOUS LOCATIONS:
 Class I, Division 2, Groups A, B, C, and D



- *PROTOCOL CONVERSION FEATURE CONVERTS NUMEROUS PROTOCOLS SIMULTANEOUSLY*
- *COMPACTFLASH® SLOT ALLOWS PROCESS DATA TO BE LOGGED DIRECTLY TO CSV FILES*
- *VIRTUAL HMI OFFERS BUILT-IN PC-BASED SCADA FUNCTIONALITY*
- *WEBSERVER PROVIDES WORLDWIDE ACCESS TO DATA LOGS AND VIRTUAL HMI*
- *EXTENSIVE BUILT-IN DRIVER LIST ALLOWS EASY DATA MAPPING TO PLCs, PCs, AND SCADA SYSTEMS*
- *ALARM NOTIFICATIONS CAN BE SENT VIA EMAIL OR TEXT MESSAGES*
- *10 BASE-T/100 BASE-TX ETHERNET CONNECTION CAN CONNECT TO AN UNLIMITED NUMBER OF DEVICES VIA FOUR PROTOCOLS SIMULTANEOUSLY*

GENERAL DESCRIPTION

The Data Station Plus was designed to act as a nexus for industrial data collection and management. The unit offers multiple protocol conversion, data logging and remote machine access. With three built in serial ports and a 10 Base-T/100 Base-TX Ethernet port, the unit performs protocol conversion, allowing disparate devices to communicate seamlessly with one another. The Ethernet port supports up to four protocols simultaneously so even Ethernet to Ethernet protocols can be converted.

The CompactFlash card allows data to be collected and stored for later review. The files are stored in simple CSV file format allowing common applications, such as Microsoft Excel and Access, to view and manage the data. The free Websync utility provides a means to synchronize the files with a PC's hard drive for permanent storage. The CompactFlash card may also be used to load new configuration files into the Data Station.

The built-in web server allows log files to be retrieved manually, and also provides access to the unique "virtual HMI". The virtual HMI is programmed just like Red Lion's G3 series of HMI. Any standard web browser such as Internet Explorer or Netscape may be used to monitor or control the HMI from a PC anywhere in the world.

The USB port may be used for blazing fast file downloads, or to mount the Data Station's CompactFlash card as an external drive to your PC.

The Data Station's DIN rail mounting saves time and panel space and snaps easily onto standard top hat (T) profile DIN rail.

SOFTWARE

The Data Station is programmed with Crimson® 2.0 software for Windows® 2000 or later platforms. The software is an easy to use graphical interface which can be purchased as part of a kit that includes a manual and cables, or downloaded free of charge from www.redlion.net.

SAFETY SUMMARY

All safety related regulations, local codes and instructions that appear in the manual or on equipment must be observed to ensure personal safety and to prevent damage to either the instrument or equipment connected to it. If equipment is used in a manner not specified by the manufacturer, the protection provided by the equipment may be impaired.

Do not use the controller to directly command motors, valves, or other actuators not equipped with safeguards. To do so can be potentially harmful to persons or equipment in the event of a fault to the controller. An independent and redundant temperature limit indicator with alarm outputs is strongly recommended.

CAUTION: Risk of Danger.
 Read complete instructions prior to installation and operation of the unit.

DIMENSIONS In inches (mm)

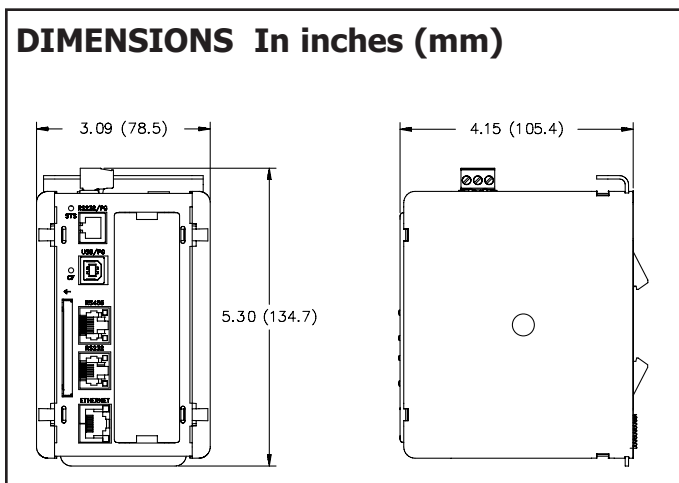

WARNING - EXPLOSION HAZARD - SUBSTITUTION OF COMPONENTS MAY IMPAIR SUITABILITY FOR CLASS I, DIVISION 2

THIS EQUIPMENT IS SUITABLE FOR USE IN CLASS I, DIVISION 2, GROUPS A, B, C, D, OR NON-HAZARDOUS LOCATIONS ONLY

CompactFlash is a registered trademark of CompactFlash Association.

SPECIFICATIONS

- POWER:** 24 VDC \pm 10%
200 mA min., without expansion card
1 Amp maximum with expansion card fitted
Must use Class 2 or SELV rated power supply.
- COMMUNICATIONS:**
USB/PG Port: Adheres to USB specification 1.1. Device only using Type B connection.



WARNING - DO NOT CONNECT OR DISCONNECT CABLES WHILE POWER IS APPLIED UNLESS AREA IS KNOWN TO BE NON-HAZARDOUS. USB PORT IS FOR SYSTEM SET-UP AND DIAGNOSTICS AND IS NOT INTENDED FOR PERMANENT CONNECTION.

- Serial Ports:** Format and Baud Rates for each port are individually software programmable up to 115,200 baud.
- RS232/PG Port:** RS232 port via RJ12
- COMMS Ports:** RS422/485 port via RJ45, and RS232 port via RJ12
- DH485 TXEN:** Transmit enable; open collector, $V_{OH} = 15$ VDC, $V_{OL} = 0.5$ V @ 25 mA max.
- Ethernet Port:** 10 BASE-T / 100 BASE-TX
RJ45 jack is wired as a NIC (Network Interface Card).
- LEDs:**
STS – Status LED indicates condition of Data Station.
TX/RX – Transmit/Receive LEDs show serial activity.
Ethernet – Link and activity LEDs.
CF – CompactFlash LED indicates card status and read/write activity
 - MEMORY:**
On-board User Memory: 4 Mbytes of non-volatile Flash memory.
On-board SDRAM:
 DPSX: 2 Mbytes
 DSPGT: 8 Mbytes
Memory Card: CompactFlash Type II slot for Type I and Type II cards.
 - REAL-TIME CLOCK:** Typical accuracy is less than one minute per month drift. Crimson 2.0's SNTP facility allows synchronization with external servers.
Battery: Lithium Coin Cell. Typical lifetime of 10 years at 25 °C.
A "Battery Low" system variable is available so that the programmer can choose specific action(s) to occur when the battery voltage drops below its nominal voltage.
 - ENVIRONMENTAL CONDITIONS:**
Operating Temperature Range: 0 to 50°C
Storage Temperature Range: -30 to +70°C
Operating and Storage Humidity: 80% max relative humidity, non-condensing, from 0 to 50°C
Vibration According to IEC 68-2-6: Operational 5 to 150 Hz, in X, Y, Z direction for 1.5 hours, 2 g's.
Shock According to IEC 68-2-27: Operational 30 g, 11 msec in 3 directions.
Altitude: Up to 2000 meters

- CONSTRUCTION:** Case body is burgundy high impact plastic and stainless steel. Installation Category I, Pollution Degree 2.
- POWER CONNECTION:** Removable wire clamp screw terminal block.
Wire Gage Capacity: 24 AWG to 12 AWG
Torque: 4.45 to 5.34 in/lb (0.5 to 0.6 N-m)
- MOUNTING:** Snaps onto standard DIN style top hat (T) profile mounting rails according to EN50022 -35 x 7.5 and -35 x 15.

10. CERTIFICATIONS AND COMPLIANCES:

SAFETY

UL Listed, File #E302106, UL508, CSA 22.2 No. 14-M05
LISTED by Und. Lab. Inc. to U.S. and Canadian safety standards
UL Listed, File #E317425, ANSI/ISA 12.12.01-2007, CSA 22.2 No. 213-M1987
LISTED by Und. Lab. Inc. to U.S. and Canadian safety standards
IEC 61010-1, EN 61010-1: Safety requirements for electrical equipment for measurement, control, and laboratory use, Part 1.

ELECTROMAGNETIC COMPATIBILITY

Emissions and Immunity to EN 61326: Electrical Equipment for Measurement, Control and Laboratory use.

Immunity to Industrial Locations:

Electrostatic discharge	EN 61000-4-2	Criterion A ² 4 kV contact discharge 8 kV air discharge
Electromagnetic RF fields	EN 61000-4-3	Criterion A 10 V/m
Fast transients (burst)	EN 61000-4-4	Criterion A 2 kV power 2 kV signal
Surge	EN 61000-4-5	Criterion A 1kV L-L, 2 kV L&N-E power
RF conducted interference	EN 61000-4-6	Criterion A 3 V/rms

Emissions:

Emissions	EN 55011	Class A
-----------	----------	---------

Notes:

- Criterion A: Normal operation within specified limits.*
- This device was designed for installation in an enclosure. To avoid electrostatic discharge to the unit in environments with static levels above 4 kV precautions should be taken when the device is mounted outside an enclosure. When working in an enclosure (ex. making adjustments, setting jumpers etc.) typical anti-static precautions should be observed before touching the unit.*

- WEIGHT:** 15.1 oz (456.4 g)



WARNING - EXPLOSION HAZARD - DO NOT DISCONNECT EQUIPMENT UNLESS POWER HAS BEEN SWITCHED OFF OR AREA IS KNOWN TO BE NON-HAZARDOUS.

HARDWARE INSTALLATION

DIN rail should be mounted horizontally so that the unit's ventilation holes are vertical in relation to cabinet orientation. A minimum clearance of 1 inch (25.4 mm) should be maintained above and below the unit in order to ensure proper thermal regulation.

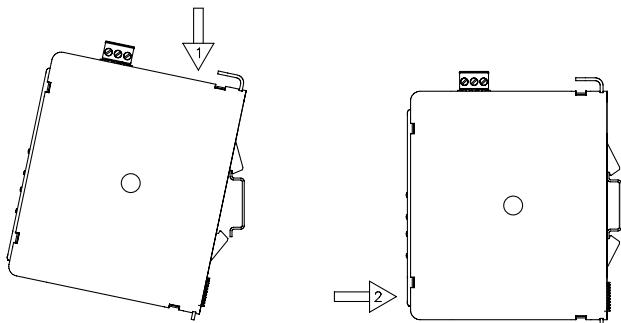
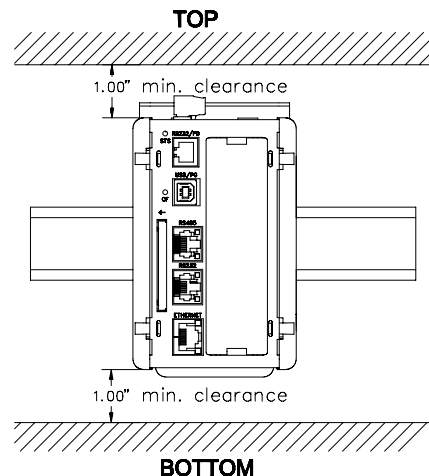
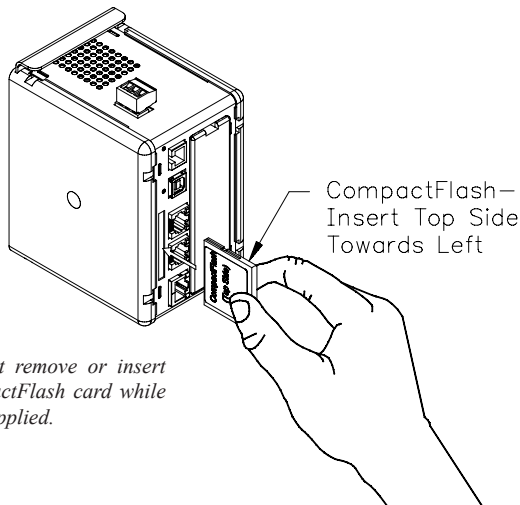

Figure 1 - Attach Data Station To DIN Rail



COMPACTFLASH® CARD

CompactFlash socket is a Type II socket that can accept either Type I or II cards. Use cards with a minimum of 4 Mbytes and a maximum of 2 Gbytes with the Data Station's CompactFlash socket. Cards are available at most computer and office supply retailers. CompactFlash can be used for configuration transfers, data logging, and trending.



Note: Do not remove or insert the CompactFlash card while power is applied.

Information stored on a CompactFlash card can be read by a card reader attached to a PC. This information is stored in IBM (Windows®) PC compatible FAT16 file format.

NOTE

For reliable operation in all of our products, Red Lion recommends the use of SanDisk® and SimpleTech brands of CompactFlash cards.

Industrial grade versions that provide up to two million write/erase cycles minimum are available from Red Lion.

EMC INSTALLATION GUIDELINES

Although Red Lion Controls Products are designed with a high degree of immunity to Electromagnetic Interference (EMI), proper installation and wiring methods must be followed to ensure compatibility in each application. The type of the electrical noise, source or coupling method into a unit may be different for various installations. Cable length, routing, and shield termination are very important and can mean the difference between a successful or troublesome installation. Listed below are some EMI guidelines for a successful installation in an industrial environment.

1. To reduce the chance of noise spikes entering the unit via the power lines, connections should be made to a clean source. Connecting to circuits that also power loads such as contactors, relays, motors, solenoids etc. should be avoided.
2. The unit should be mounted in a metal enclosure, which is properly connected to protective earth.
3. Use shielded (screened) cables for all Signal and Control inputs. The shield (screen) pigtail connection should be made as short as possible. The connection point for the shield depends somewhat upon the application. Listed below are the recommended methods of connecting the shield, in order of their effectiveness.
 - a. Connect the shield to earth ground (protective earth) at one end where the unit is mounted.
 - b. Connect the shield to earth ground at both ends of the cable, usually when the noise source frequency is over 1 MHz.
 - c. Connect the shield to common of the Data Station and leave the other end of the shield unconnected and insulated from earth ground.

POWER SUPPLY REQUIREMENTS

It is very important that the power supply is mounted correctly if the unit is to operate reliably. Please take care to observe the following points:

- The power supply must be mounted close to the unit, with usually not more than 6 feet (1.8 m) of cable between the supply and the Data Station. Ideally, the shortest length possible should be used.
- The wire used to connect the Data Station's power supply should be at least 22-gage wire. If a longer cable run is used, a heavier gage wire should be used. The routing of the cable should be kept away from large contactors, inverters, and other devices which may generate significant electrical noise.
- A power supply with a Class 2 or SELV rating is to be used. A Class 2 or SELV power supply provides isolation to accessible circuits from hazardous voltage levels generated by a mains power supply due to single faults. SELV is an acronym for "safety extra-low voltage." Safety extra-low voltage circuits shall exhibit voltages safe to touch both under normal operating conditions and after a single fault, such as a breakdown of a layer of basic insulation or after the failure of a single component has occurred.

Visit www.redlion.net for a complete list of our PSDR Series of Class 2 power supplies.

4. Never run Signal or Control cables in the same conduit or raceway with AC power lines, conductors feeding motors, solenoids, SCR controls, and heaters, etc. The cables should be run through metal conduit that is properly grounded. This is especially useful in applications where cable runs are long and portable two-way radios are used in close proximity or if the installation is near a commercial radio transmitter. Also, Signal or Control cables within an enclosure should be routed as far away as possible from contactors, control relays, transformers, and other noisy components.
 5. Long cable runs are more susceptible to EMI pickup than short cable runs. Therefore, keep cable runs as short as possible.
 6. In extremely high EMI environments, the use of external EMI suppression devices is effective. The following EMI suppression devices (or equivalent) are recommended:
 - Ferrite Suppression Cores for signal and control cables:
 - Fair-Rite part number 0443167251 (RLC part number FCOR0000)
 - TDK part number ZCAT3035-1330A
 - Steward part number 28B2029-0A0
 - Line Filters for input power cables:
 - Schaffner part number FN610-1/07 (RLC part number LFIL0000)
 - Schaffner part number FN670-1.8/07
 - Corcom part number 1 VR3
- Visit RLC's web site at www.redlion.net for more information on EMI guidelines, Safety and CE issues as they relate to Red Lion Controls products.

WIRING

POWER CONNECTION

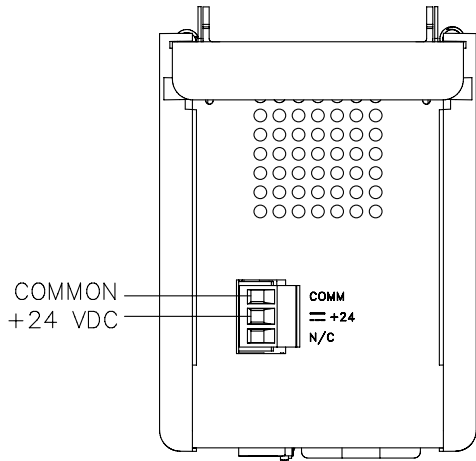

WARNING - EXPLOSION HAZARD - DO NOT DISCONNECT WHILE CIRCUIT IS ALIVE UNLESS AREA IS KNOWN TO BE NON-HAZARDOUS.

INPUT AND OUTPUT (I/O) WIRING MUST BE IN ACCORDANCE WITH CLASS I, DIV. 2 WIRING METHODS AND IN ACCORDANCE WITH THE AUTHORITY HAVING JURISDICTION.

PROGRAMMING PORTS

RS232/PG

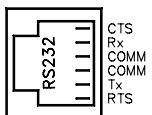

USB/PG

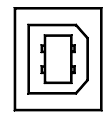

ETHERNET

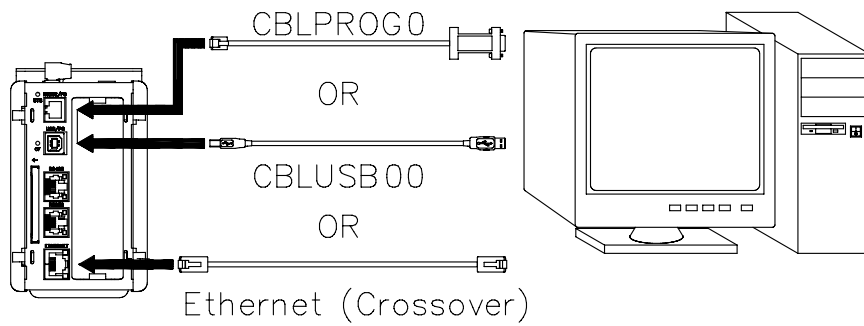

COMMUNICATION PORTS

RS232/PG

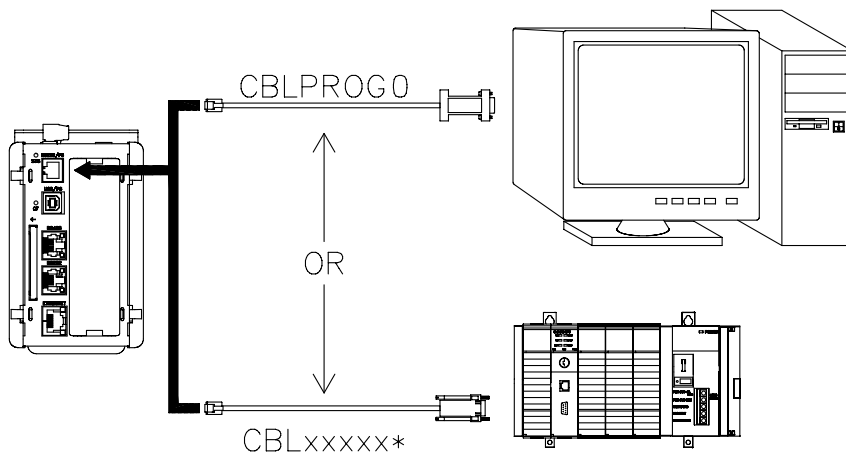
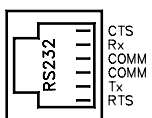

RS232

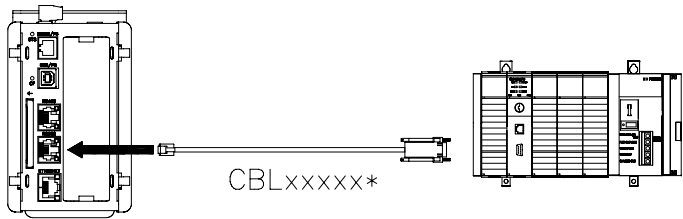
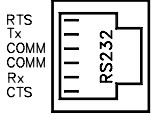

* Use appropriate communications cable. See Ordering Information for descriptions of the available cables.

RS485

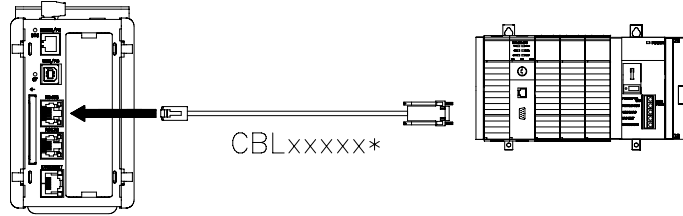
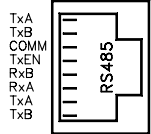

WARNING: Do **NOT** use a standard DH-485 cable to connect this port to Allen Bradley equipment.

PORT 3 - ETHERNET CONNECTION

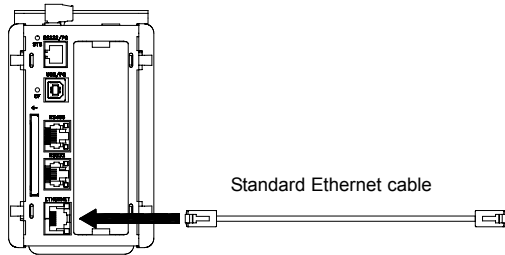

DATA STATION PORT PIN OUTS

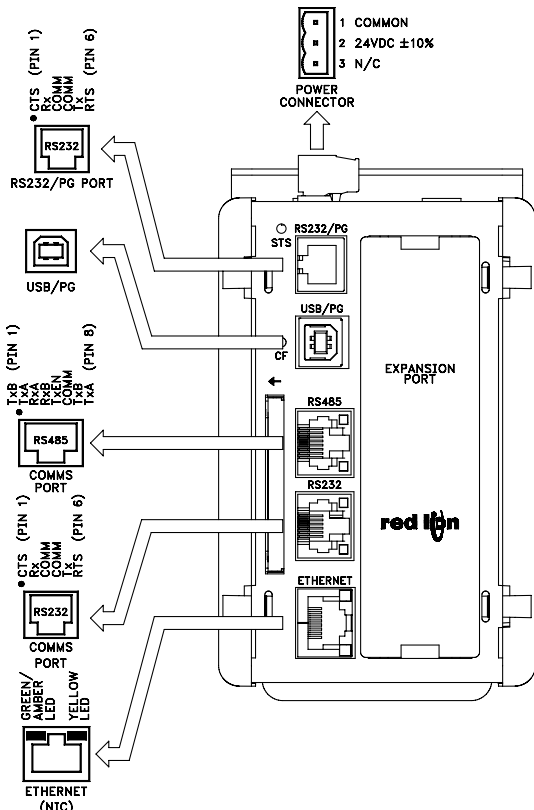

TROUBLESHOOTING

If for any reason you have trouble operating, connecting, or simply have questions concerning your new Data Station, contact Red Lion's technical support. For contact information, refer to the back page of this bulletin for phone and fax numbers.

EMAIL: techsupport@redlion.net
 Web Site: <http://www.redlion.net>

COMMUNICATING WITH THE DATA STATION

CONFIGURING A DATA STATION

The Data Station is configured using Crimson® 2.0 software. Crimson 2.0 is available as a free download from Red Lion's website, or it can be ordered on CD. Updates to the software for new features and drivers are posted on the website as they become available. By configuring the Data Station using the latest version of the software, you are assured that your unit has the most up to date feature set. Crimson® 2.0 software can configure the Data Station through the RS232/PG port, USB/PG port, Ethernet, or CompactFlash. The USB/PG port is connected using a standard USB cable with a Type B connector.

The driver needed to use the USB port will be installed with Crimson 2.0. The RS232/PG port uses a programming cable made by Red Lion to connect to the DB9 COM port of your computer. If making your own cable, refer to the "Data Station Port Pin Outs" for wiring information.

The CompactFlash can be used to program a Data Station by placing a configuration file and firmware on the CompactFlash card. The card is then inserted into the target Data Station and powered. Refer to the Crimson® 2.0 literature for more information on the proper names and locations of the files.

CABLES AND DRIVERS

Red Lion has a wide range of cables and drivers for use with many different communication types. A list of these drivers and cables along with pin outs is available from Red Lion's website. New cables and drivers are added on a regular basis. If making your own cable, refer to the "Data Station Port Pin Outs" for wiring information.

USB, DATA TRANSFERS FROM THE COMPACTFLASH CARD



WARNING - DO NOT CONNECT OR DISCONNECT CABLES WHILE POWER IS APPLIED UNLESS AREA IS KNOWN TO BE NON-HAZARDOUS. USB PORT IS FOR SYSTEM SET-UP AND DIAGNOSTICS AND IS NOT INTENDED FOR PERMANENT CONNECTION.

In order to transfer data from the CompactFlash card via the USB port, a driver must be installed on your computer. This driver is installed with Crimson 2.0 and is located in the folder C:\Program Files\Red Lion Controls\Crimson 2.0\Device\ after Crimson 2.0 is installed. This may have already been accomplished if your Data Station was configured using the USB port.

Once the driver is installed, connect the Data Station to your PC with a USB cable, and follow "Mounting the CompactFlash" instructions in the Crimson 2.0 user manual.

Note that using the USB port for frequent data transfers is not recommended. For frequent data transfers it is recommended that the Ethernet connection be used. Through the Ethernet connection a web page can be set up to view logged data. Refer to the Crimson 2.0 manual for details.

Note: The USB port is for system set-up and diagnostics and is not intended for permanent connection.

ETHERNET COMMUNICATIONS

Ethernet communications can be established at either 10 BASE-T or 100 BASE-TX. The Data Station's RJ45 jack is wired as a NIC (Network Interface Card). For example, when wiring to a hub or switch use a straight-through cable, but when connecting to another NIC use a crossover cable.

The Crimson 2.0 manual contains additional information on Ethernet communications.

RS232 PORTS

The Data Station has two RS232 ports. There is the RS232/PG port and the COMMS port. Although only one of these ports can be used for programming, both ports can be used for communications with a PLC. The RS232/PG port can be used for either master or slave protocols.

RS422/485 PORT

The Data Station has one RS422/485 port. This port can be configured to act as either RS422 or RS485.

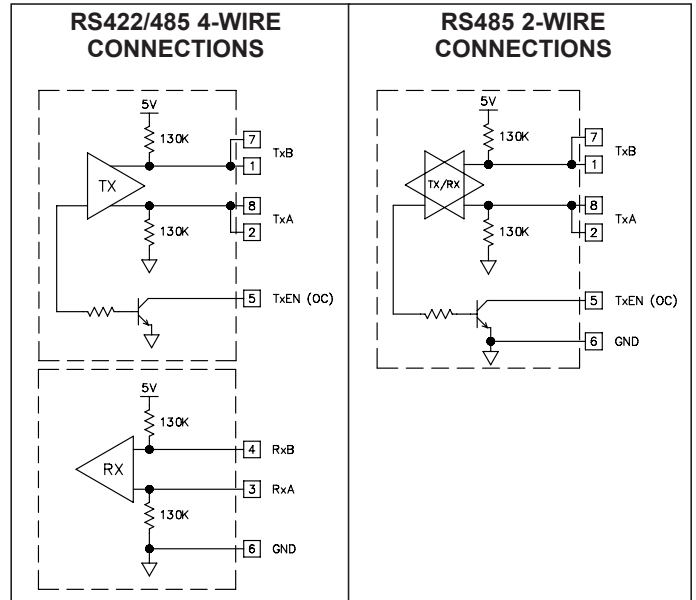

Note: All Red Lion® devices connect A to A and B to B, except for Paradigm devices. Refer to www.redlion.net for additional information.

DH485 COMMUNICATIONS

The Data Station's RS422/485 COMMS port can also be used for Allen Bradley DH485 communications.

WARNING: DO NOT use a standard DH485 cable to connect this port to Allen Bradley equipment. A cable and wiring diagram are available from Red Lion.

LEDS

STS – STATUS LED

The green Status LED provides information regarding the state of the Data Station. This includes indication of the various stages of the start-up routine (power-up), and any errors that may occur.

Startup Routine

	INDICATION
Rapidly Flashing	Data Station is currently running the boot loader and/or being flash upgraded by Crimson.
Steady	Data Station is operating properly.

CF – COMPACTFLASH LED

LED	INDICATION
Off	No CompactFlash Card is present.
Steady	Valid CompactFlash card is present.
Flashing Rapidly	CompactFlash card is being checked.
Flickering	Unit is writing to the CompactFlash, either because it is storing data, or because the PC connected via the USB port has locked the drive. ¹
Flashing Slowly	Incorrectly formatted CompactFlash card present.

1. Do not turn off power to the unit while this light is flickering. The unit writes data in two minute intervals. Later Microsoft operating systems will not lock the drive unless they need to write data; Windows 98 may lock the drive any time it is mounted, thereby interfering with logging. Refer to "Mounting the CompactFlash" in the Crimson 2.0 User Manual.

USER COMMUNICATION PORTS - TX/RX LEDS

LED	INDICATION
GREEN	Transmitting
RED	Receiving

Note: LEDs are not available on the Programming Port: RS232/PG.

ETHERNET LEDS

LED	INDICATION
YELLOW (Solid)	Link Established
YELLOW (Flashing)	Network Activity
GREEN	10 BASE-T Communications
AMBER	100 BASE-TX Communications

ORDERING INFORMATION

TYPE	MODEL NO.	DESCRIPTION	PART NUMBER
Data Station Plus	DSP	Data Station with multiple protocol converter, data logger, web server with Virtual HMI up to QVGA (320 x 240) and expansion slot.	DSPSX000
		Data Station with multiple protocol converter, data logger, web server with Virtual HMI up to VGA (640 x 480) size and expansion slot with increased SDRAM.	DSPGT000
Communications Cables (10 feet)	CBL	RS-232 Programming Cable	CBLPROG0
		USB Cable	CBLUSB00
		Communications Cables ¹	CBLxxxxx
Software	SFCRM2	Crimson [®] 2.0 ² , Manual and Download Cable	SFCRM200
Power Supply	PSDR	DIN Rail Power Supply	PSDRxxx
Accessories	XCCN	CANopen option card for Modular Controller or Data Station Plus	XCCN0000
	XCDN	DeviceNet option card for Modular Controller or Data Station Plus	XCDN0000
	XCPB	PROFIBUS option card for Modular Controller or Data Station Plus	XCPBDP00
	XCRS	RS232/485 option card for Modular Controller or Data Station Plus	XCRS0000
	G3CF	64 MB CompactFlash Card ⁴	G3CF064M
		256 MB CompactFlash Card ⁴	G3CF256M
512 MB CompactFlash Card ⁴		G3CF512M	
DR	DIN Rail Mountable Adapter Products ³	DRxxxxxx	

¹ Visit www.redlion.net for a list of communication drivers and cables.

² Use this part number to purchase the Crimson[®] software on CD with a printed manual, USB cable, and RS-232 cable. Otherwise, download free of charge from www.redlion.net.

³ Red Lion offers RJ modular jack adapters. Refer to the DR literature for complete details.

⁴ Industrial grade two million write cycles.

LIMITED WARRANTY

The Company warrants the products it manufactures against defects in materials and workmanship for a period limited to two years from the date of shipment, provided the products have been stored, handled, installed, and used under proper conditions. The Company's liability under this limited warranty shall extend only to the repair or replacement of a defective product, at The Company's option. The Company disclaims all liability for any affirmation, promise or representation with respect to the products.

The customer agrees to hold Red Lion Controls harmless from, defend, and indemnify RLC against damages, claims, and expenses arising out of subsequent sales of RLC products or products containing components manufactured by RLC and based upon personal injuries, deaths, property damage, lost profits, and other matters which Buyer, its employees, or sub-contractors are or may be to any extent liable, including without limitation penalties imposed by the Consumer Product Safety Act (P.L. 92-573) and liability imposed upon any person pursuant to the Magnuson-Moss Warranty Act (P.L. 93-637), as now in effect or as amended hereafter.

No warranties expressed or implied are created with respect to The Company's products except those expressly contained herein. The Customer acknowledges the disclaimers and limitations contained herein and relies on no other warranties or affirmations.

Red Lion Controls
20 Willow Springs Circle
York PA 17406
Tel +1 (717) 767-6511
Fax +1 (717) 764-0839

Red Lion Controls BV
Printerweg 10
NL - 3821 AD Amersfoort
Tel +31 (0) 334 723 225
Fax +31 (0) 334 893 793

Red Lion Controls AP
Unit 101, XinAn Plaza
Building 13, No.99 Tianzhou Road
ShangHai, P.R. China 200223
Tel +86 21 6113-3688
Fax +86 21 6113-3683